



Struttura in legno con imbottitura in poliuretano espanso indeformabile a densità differenziata rivestito in tessuto protettivo accoppiato. Cuscini seduta in poliuretano espanso indeformabile a densità differenziata rivestito in tessuto protettivo accoppiato. Cuscini schienale in piuma d'oca. Piedi in alluminio pressofuso, cromato o color peltro o black nickel. Il modello Michel è completamente sfoderabile nella versione in tessuto. Nella versione in pelle è fisso.

Wooden frame with non-deformable differentiated density polyurethane foam padding covered in a protective fabric. Seat cushions in stress-resistant differentiated density polyurethane foam covered in a protective fabric. Back cushions in goose down. Feet in die-cast aluminium, chrome-plated or pewter-coloured or black nickel. The Michel model has completely removable covers in the fabric version. In the leather version it is fixed.

Holzrahmen mit nicht verformbarer Polyurethanschaum-Polsterung unterschiedlicher Dichte, die mit einem schützenden Stoff überzogen ist. Sitzkissen aus strapazierfähigem Polyurethanschaum mit differenzierter Dichte, bezogen mit einem schützenden Stoff. Rückenkissen aus Gänsedaunen. Füße aus Aluminiumdruckguss, verchromt, zinnfarben oder schwarz vernickelt. Das Modell Michel hat in der Stoffversion vollständig abnehmbare Bezüge. In der Lederversion ist das Problem behoben.

Structure en bois avec rembourrage indéformable en mousse de polyuréthane à densité différenciée, recouvert d'un tissu de protection. Coussins d'assise en mousse de polyuréthane à densité différenciée, résistant aux contraintes et recouvert d'un tissu de protection. Coussins de dos en duvet d'oie. Pieds en aluminium moulé sous pression, chrome ou couleur étain ou nickel noir. Le modèle Michel est doté de couvertures entièrement amovibles dans la version de tissu. Dans la version en cuir, c'est corrigé.

Estructura de madera con alcohado de espuma de poliuretano de densidad diferenciada e indeformable, recubierto de un tejido protector. Cojines de asiento de espuma de poliuretano de densidad diferenciada resistente a la tensión y recubierto de un tejido protector. Cojines de respaldo de plumas de ganso. Pies de aluminio fundido a presión, cromados o de color peltre o níquel negro. El modelo Michel dispone de fundas completamente desmontables en la versión de tela. En la versión de cuero está arreglado.

DIMENSION

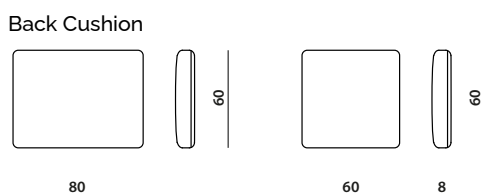
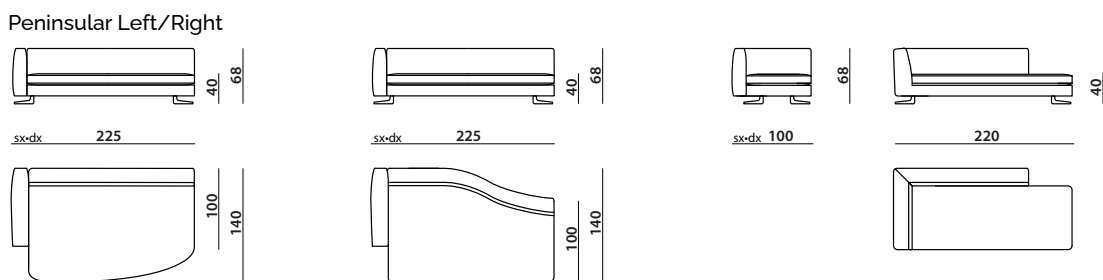
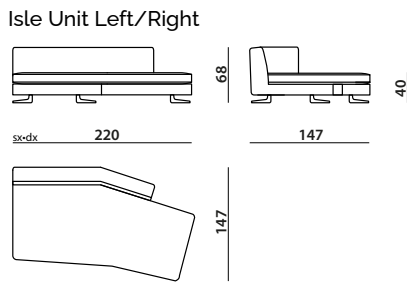
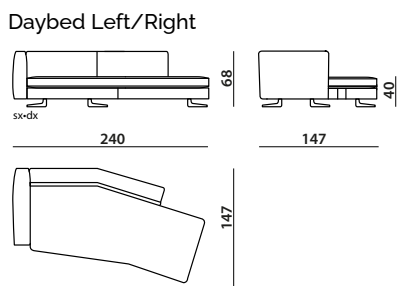
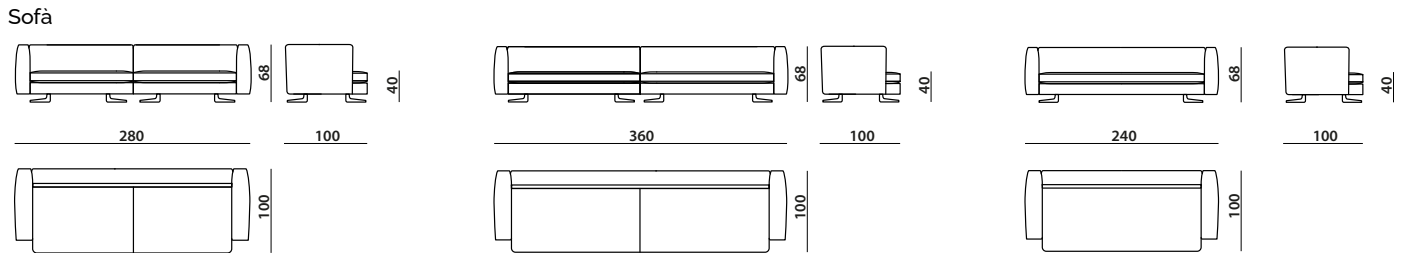

DIMENSION

Corner

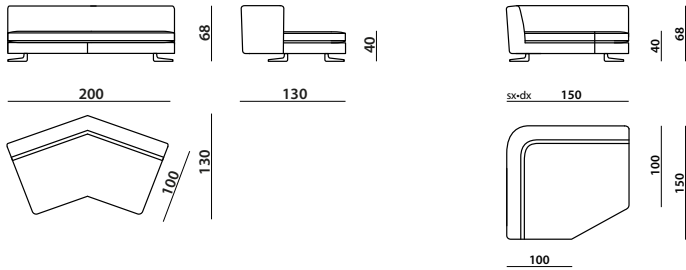

Corner

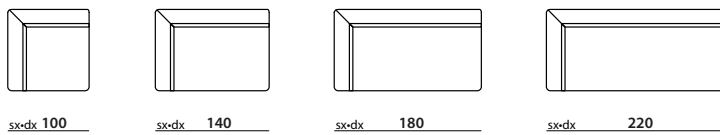

Central Element

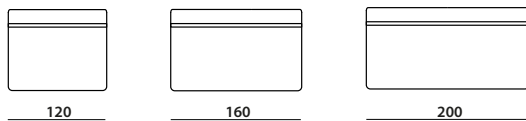

Peninsular Left/Right

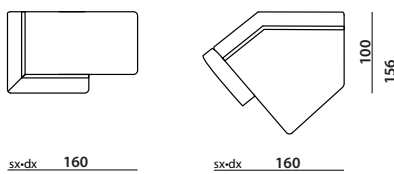

Armrest Cushions

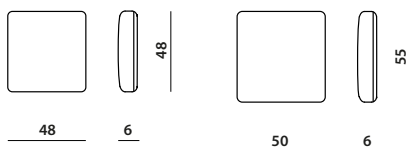

Sofà

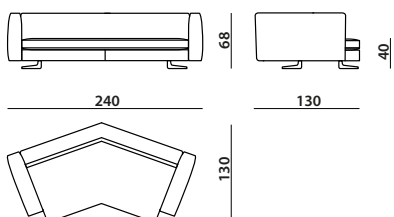

DIMENSION

End Unit Left/Right

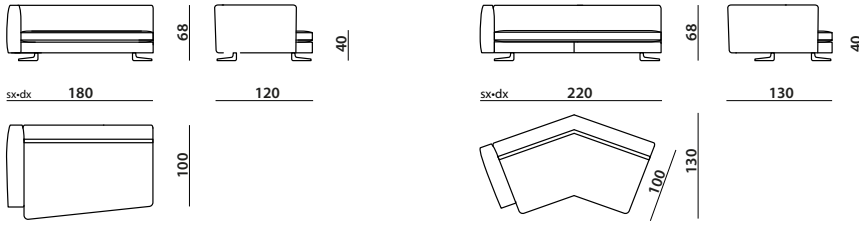

End Unit Left/Right

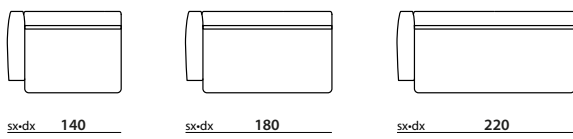

MICHEL

SOFA

ALCHYMIA

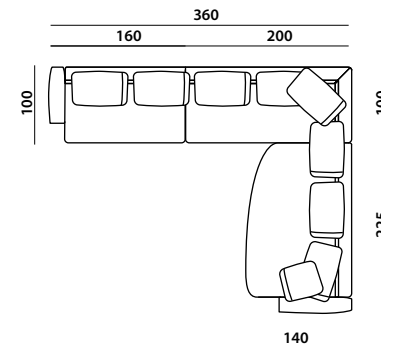
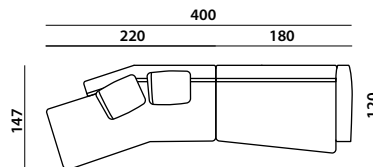
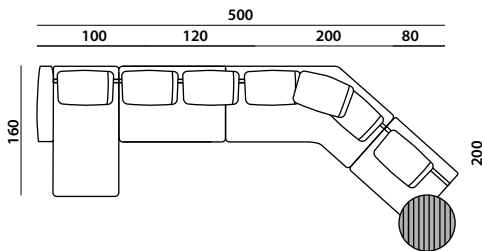
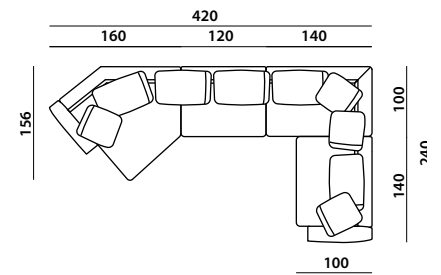
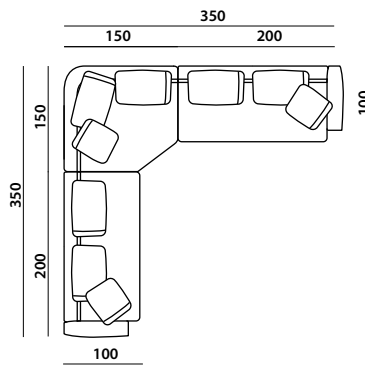
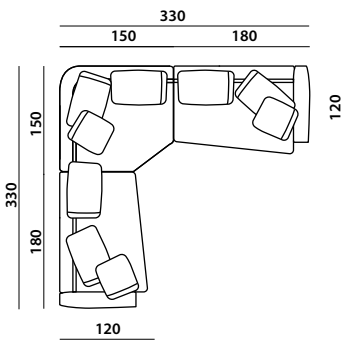
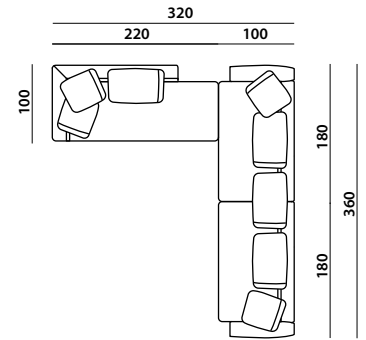
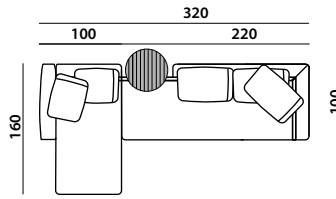
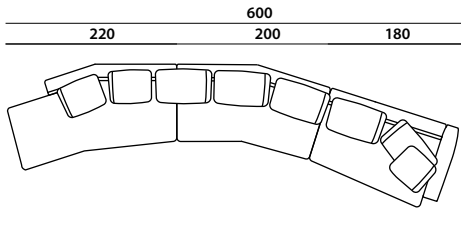

MICHEL

SOFA

ALCHYMIA

